

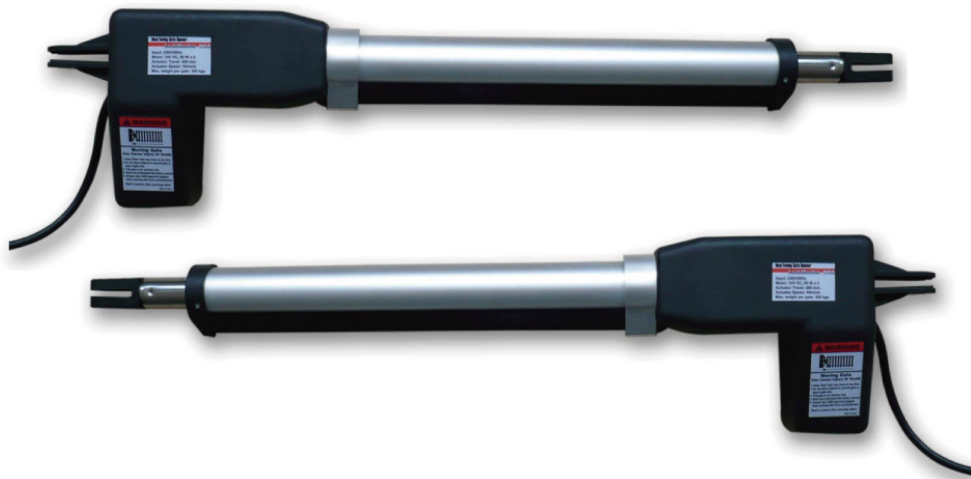

# *Swing Gate Opener*

**KNL 02** (Dual Actuator)

**KNL 01** (Single Actuator)



## **Installation and Operating Manual**

- Please read this manual and the enclosed safety materials carefully before install and use
- Periodic checks of the opener are required to ensure safe operation.
- For residential use only

✓N27983



CE EMC

# Table of Contents

Safety Installation Information .....	2-3
Dual Gate Opener Parts List (KNL 02) .....	4
Single Gate Opener Parts List (KNL 01) .....	5
Optional Accessories Parts List.....	6
Technical Specifications & Features .....	7-8
Installation Overview .....	9-10
Preparation for Installation.....	10-11
Determining the Position of Mounting Hardware.....	11-14
Installing the Mounting Hardware.....	14-15
Installing the Opener.....	15-16
Mounting the Control Box .....	16-17
Connecting of the control board .....	18-20
How to learn or erase the remote.....	20
Setting of the control board.....	21-24
Indicate Illustration on Digital Display When Gate Opener Is Running .....	24
Adjusting the Limit Switch .....	24-25
How to Operate .....	25
Emergency Release .....	25
Installation for Push-to-Open Gates.....	25-26
Maintenance.....	27
Trouble Shooting.....	27-28
Quick-Setting Guide.....	29-32
Notice.....	33

# Safety Installation Information

1. READ and FOLLOW all instruction.
2. The gate opener is intended for use with Class I vehicular swing gates.  
Class I denotes a vehicular gate opener (or system) dwellings, or a garage or parking area associated therewith.  
Install the gate opener only when the opener is appropriate for the construction and the usage class of the gate.
3. Gate opening system designers, installers and users must take into account the possible hazards associated with each individual application. Improperly designed, installed or maintained systems can create risks for the user as well as the bystander. Gate system design and installation must reduce public exposure to potential hazards. All exposed pinch points must be eliminated or guarded.
4. A gate opener can create high levels of force during normal operation. Therefore, safety features must be incorporated into every installation. Specific safety features include safety sensors.
5. The gate must be properly installed and work freely in both directions prior to the installation of the gate opener.
6. The gate must be installed in a location so that enough clearance is provided between the gate and adjacent structure when opening and closing to reduce the risk of entrapment. Swinging gates shall not open into public access areas.
7. The opener is intended for use only on gates used for vehicles. Pedestrians must be supplied with a separate access opening. The pedestrian access opening shall be designed to promote pedestrian usage. The pedestrian access shall be located such that persons will not come in contact with the moving vehicular gate.

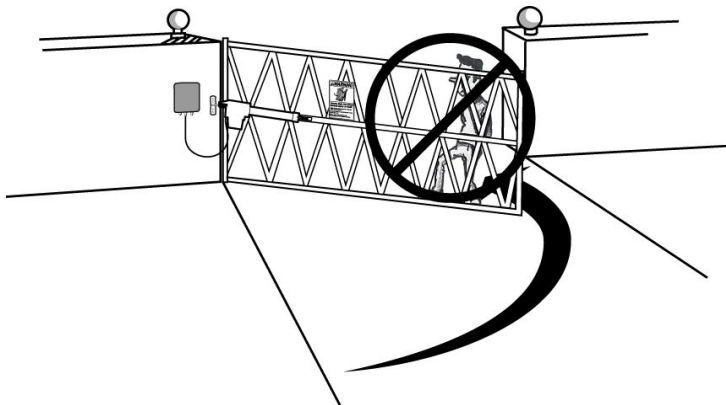

8. Pedestrians should never cross the pathway of a moving gate. The gate opener is not acceptable for use on any pedestrian gate. Pedestrians must be supplied with a separate pedestrian access.
9. For an installation utilizing non-contact sensors (safety sensors), see product manual on the placement of non-contact sensors (safety sensors) for each type of application.
  - a. Care shall be exercised to reduce the risk of nuisance tripping, such as when a vehicle trips the safety sensor while the gate is still moving.
  - b. One or more non-contact sensors (safety sensors) shall be located where the risk of entrapment of obstruction exists, such as the perimeter reachable by a moving gate or barrier.
10. Never mount any device that operates the gate opener where the user can reach over, under, around or through the gate to operate the controls. Controls are to be placed at least 6' (1.8m) from any part of the moving gate.

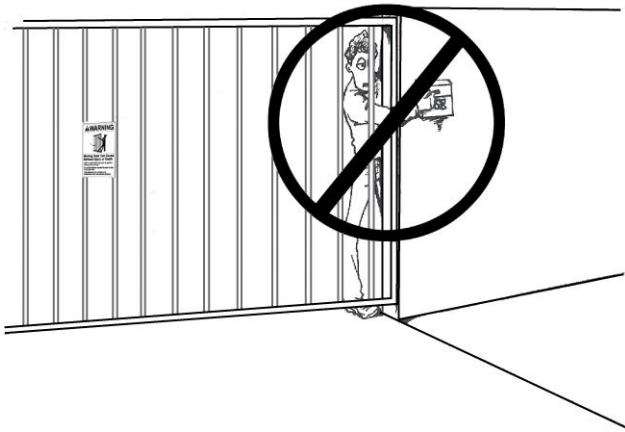

11. Controls intended to be used to reset an operator after 2 sequential activations of the entrapment protection device or devices must be located in the line of sight of the gate, or easily accessible controls shall have a security feature to prevent unauthorized use. Never allow anyone to hang on or ride the gate during the entire travel of the gate.
12. Each gate opener is provided with two safety warning placards. The placards are to be installed on the front and back of the gate where they are plainly visible. The placards may be mounted using cable ties through the four holes provided on each placard.  
All warning signs and placards must be installed where visible in the area of the gate.

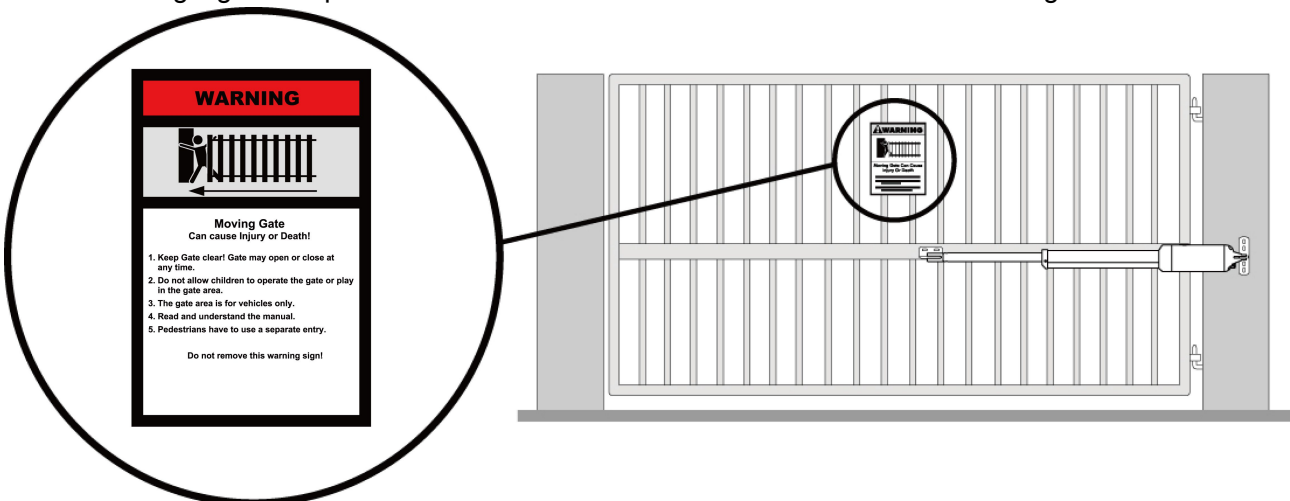

13. To AVOID damaging gas, power, or other underground utility lines, contact underground utility locating companies BEFORE digging.  
SAVE INSTRUCTION.











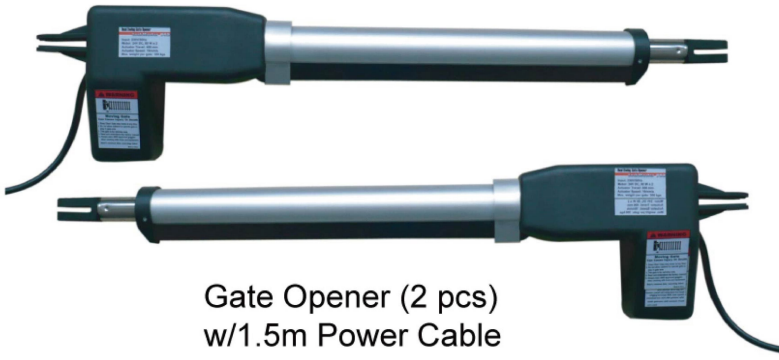

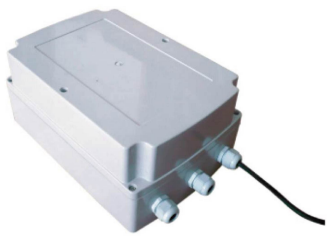





 <b>WARNING</b>
<p>To prevent SERIOUS INJURY or DEATH from a moving gate:</p> <ul style="list-style-type: none"> <li>• Install warning signs on the front and back of the gate in PLAIN VIEW.</li> <li>• Permanently secure each warning sign in a suitable manner using fastening holes.</li> </ul>

14. Do not permit children to play on or around the gate and keep all controls out of their reach.















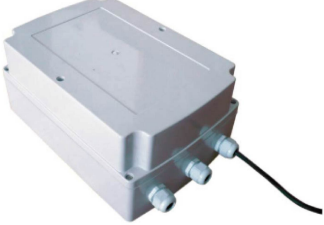





# Dual Gate Opener Parts List (KNL 02)

## Opener and Mounting Hardware

 <p>Gate Opener (2 pcs) w/1.5m Power Cable</p>		<div style="border: 2px solid black; padding: 5px;"> <p style="text-align: center; background-color: red; color: white; margin: 0;"><b>WARNING</b></p>  <p style="text-align: center; margin: 5px 0;"><b>Moving Gate</b> Can cause Injury or Death!</p> <ol style="list-style-type: none"> <li>1. Keep Gate clear! Gate may open or close at any time.</li> <li>2. Do not allow children to operate the gate or play in the gate area.</li> <li>3. The gate area is for vehicles only.</li> <li>4. Read and understand the manual.</li> <li>5. Pedestrians have to use a separate entry.</li> </ol> <p style="text-align: center; font-size: small; margin: 5px 0;">Do not remove this warning sign!</p> </div> <p style="text-align: center;">Warning Signs (4 pcs)</p>
 <p>Control Box (1 pc)</p>	 <p>CE Remote Control (3 pcs)</p>	
 <p>Post Bracket (4 pcs)</p>	 <p>Post Pivot Bracket (2 pcs)</p>	 <p>Gate Bracket (2 pcs)</p>
<b>Hardware</b>		
 <p>Φ10 Washer (14 pcs)</p>	 <p>M10×200 Bolt (8 pcs)</p>	
 <p>Φ10 Lock Washer (14 pcs)</p>	 <p>M10×75 Bolt (4 pcs)</p>	
 <p>Φ8 Washer (2 pcs)</p>	 <p>M10×30 Bolt (2 pcs)</p>	
 <p>M10 Nut (14 pcs)</p>	 <p>M8×30 Bolt (2 pcs)</p>	
 <p>M8 Nut (2 pcs)</p>	 <p>12×40 Clevis Pin (2 pcs)</p>	
 <p>Hairpin Clip (4 pcs)</p>	 <p>12×30 Clevis Pin (2 pcs)</p>	

# Single Gate Opener Parts List (KNL 01)

## Opener and Mounting Hardware

 <p>Gate Opener (1 pc) w/1.5m Power Cable</p>		 <p><b>WARNING</b></p> <p><b>Moving Gate</b> Can cause Injury or Death!</p> <ol style="list-style-type: none"> <li>1. Keep Gate clear! Gate may open or close at any time.</li> <li>2. Do not allow children to operate the gate or play in the gate area.</li> <li>3. The gate area is for vehicles only.</li> <li>4. Read and understand the manual.</li> <li>5. Pedestrians have to use a separate entry.</li> </ol> <p>Do not remove this warning sign!</p>
 <p>Control Box (1 pc)</p>	 <p>CE Remote Control (3 pcs)</p>	
 <p>Post Bracket (2 pcs)</p>	 <p>Post Pivot Bracket (1 pcs)</p>	 <p>Gate Bracket (1 pcs)</p>
<b>Hardware</b>		
 <p>Φ10 Washer (7 pcs)</p>	 <p>M10×200 Bolt (4 pcs)</p>	
 <p>Φ10 Lock Washer (7 pcs)</p>	 <p>M10×75 Bolt (2 pcs)</p>	
 <p>Φ8 Washer (1 pc)</p>	 <p>M10×30 Bolt (1 pc)</p>	
 <p>M10 Nut (7 pcs)</p>	 <p>M8×30 Bolt (1 pc)</p>	
 <p>M8 Nut (1 pc)</p>	 <p>12×40 Clevis Pin (1 pc)</p>	
 <p>Hairpin Clip (2 pcs)</p>	 <p>12×30 Clevis Pin (1 pc)</p>	

# Optional Accessories Parts List

Optional				
 <p>Back up battery (1 set) (KNL125)</p>	 <p>GSM Remote Control Switch (1pc)(KNL180)</p>	 <p>Wall push button (1 pc) (KNL147)</p>	 <p>PSO Part (1 pc) (KNL112)</p>	
 <p>Back up battery box(1 pc) (KNL130)</p>	 <p>Alarm Lamp (1 pc) (KNL140)</p>	 <p>Photocell Beam System (1 set) (KNL102)</p>	 <p>Electric Lock (1 set) (KNL149)</p>	
 <p>Wireless Push Button (1pc)(KNL 173)</p>	 <p>Solar panel (1 pc) (KNL109)</p>	 <p>Supporting frame for solar panel (1 pc) (KNL115)</p>	 <p>Bracket for solar panel (1 pc) (KNL116)</p>	
 <p>Wireless Keypad (1 pc) (KNL172)</p>	 <p>Wired Keypad (1 pc)(KNL106) ID card (KNL170)</p>	 <p>Mounting post for keypad (1 pc) (KNL107)</p>	 <p>External Receiver (1 pc) (KNL138)</p>	
 <p>Loop Detector (1 pc) (KNL155)</p>	 <p>Exit Wand (1 pc) (KNL157)</p>	 <p>5-core wire (KNL150 Wire A)</p>	 <p>2 x 0.3 sq.mm (KNL151 Wire B)</p>	 <p>2 x 0.75 sq.mm (KNL152 Wire C)</p>
 <p>Retro-reflective Photocell (1pc)(KNL 104)</p>				

## Tools Needed:

- Power Drill
- Tape Measure
- Open End Wrenches — 14# & 17# or Adjustable Wrenches
- Wire Strippers
- C-Clamps — small, medium, and large
- Level
- Hacksaw or Heavy Duty Bolt Cutters
- Phillips Screwdriver
- An extra person will be helpful

## Technical Specifications & Features

### Specifications:

- Input: 240V/50Hz
- Motor voltage: 24VDC
- Power: 80W each actuator
- Current: 3A
- Actuator speed: 16mm/s
- Max. actuator travel: 385mm
- Max. Weight per a gate: 500kg
- Max. Width per a gate: 4.5m
- Ambient Temperature: -20°C ~ +50°C (-4°F to 122°F)
- Protection class: IP44

Notice: Max. Weight and Max. Width per a gate effects only when the gate is correctly and properly installed and in good smooth.

## **Features:**

- Soft start and soft stop
- Emergency release key in case of power failure
- Dual/Single gate running mode
- Adjustable opening/closing interval between master and slave gate
- Stop/Reverse in case of obstruction during gate opening/closing.
- Built in adjustable auto-close (0-99 seconds)
- Built in max. Motor running time (MRT) adjustable for multiple safety protection (1-50 seconds)
- Digital display indicates the running situation and setting menu
- Reliable electromagnetism limit for easy adjustment
- Can be equipped with a wide range of accessories (see part list in Page 6)

# Installation Overview

## Single Gate Overview Pull-to-Open Gate

<b>⚠ WARNING</b>
To prevent <b>SERIOUS INJURY</b> or <b>DEATH</b> , at least one non-contact sensor should be located where the risk of entrapment or obstruction exists.

### Left-Hand Gate

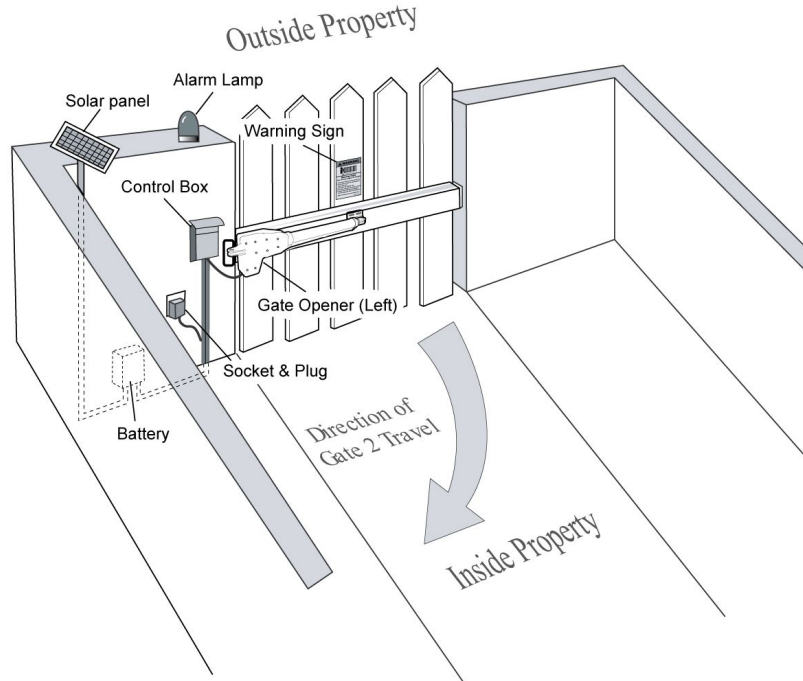

### Right-Hand Gate

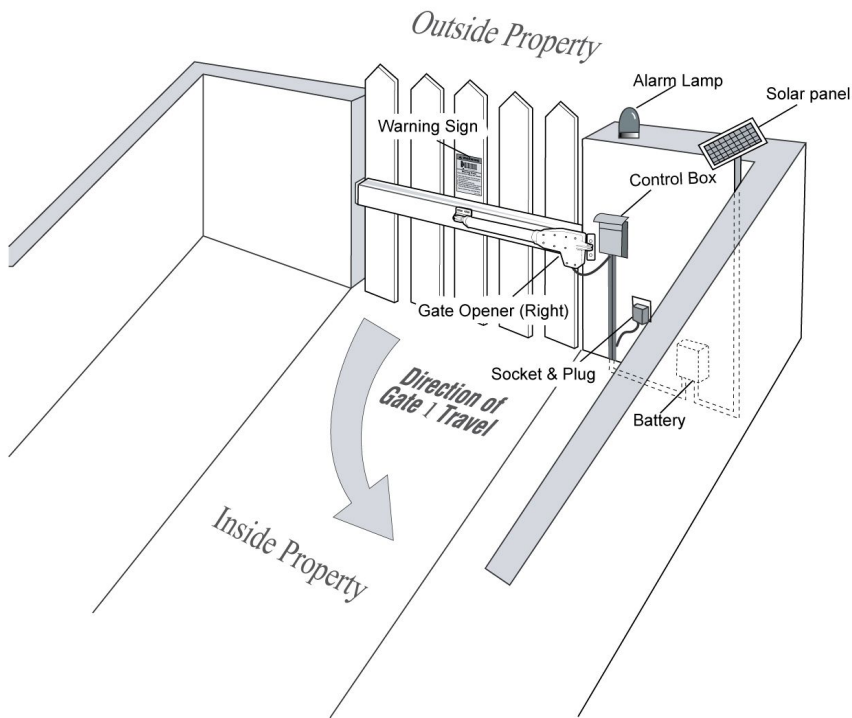



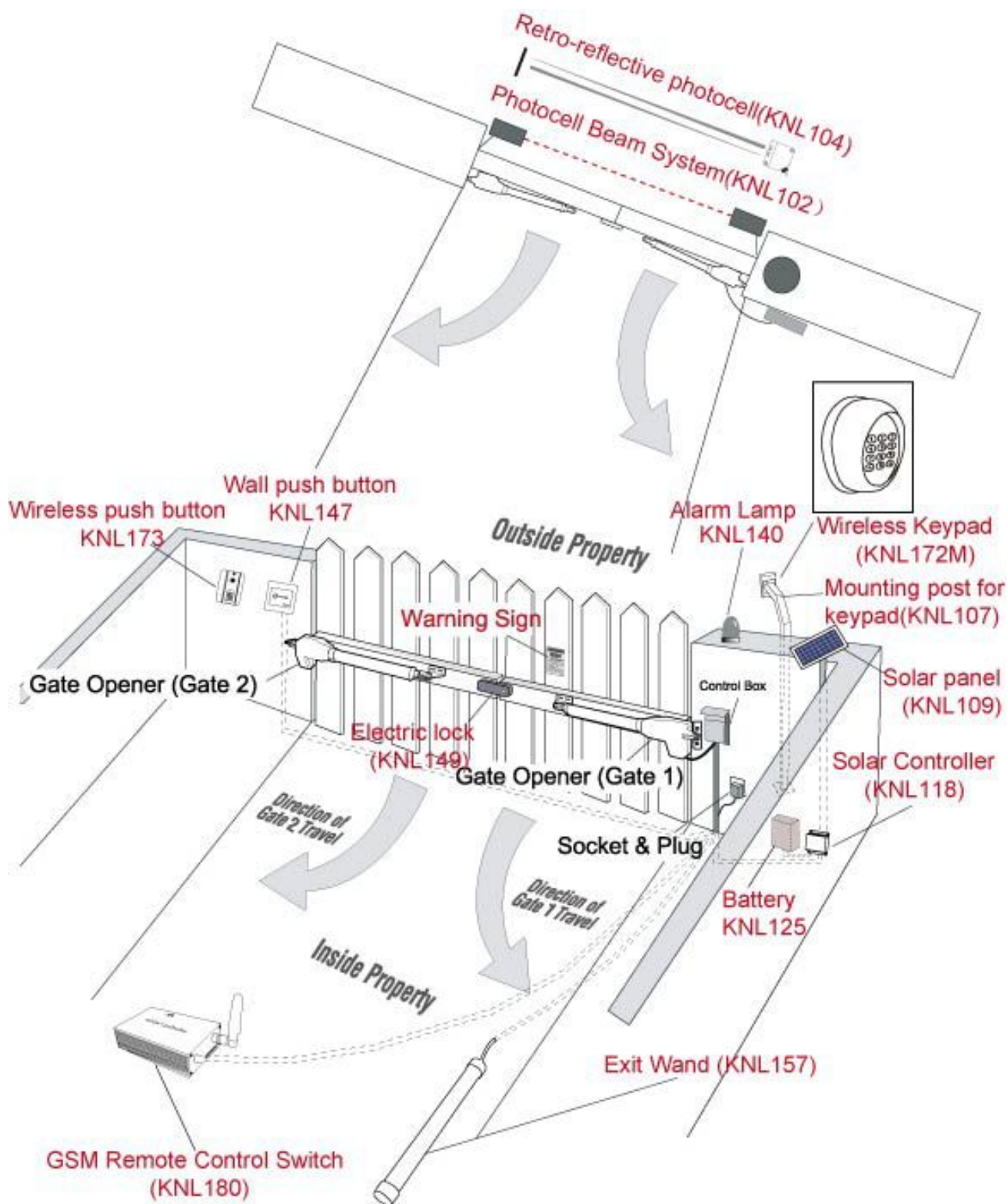

## Preparation for Installation

The proper position of the post brackets is a decisive factor to the efficiency and leverage of the gate opener. The distance (usually it is 2.5cm /1 inch or more) between the gate opener and the gate is also determined by the proper position of the post brackets.

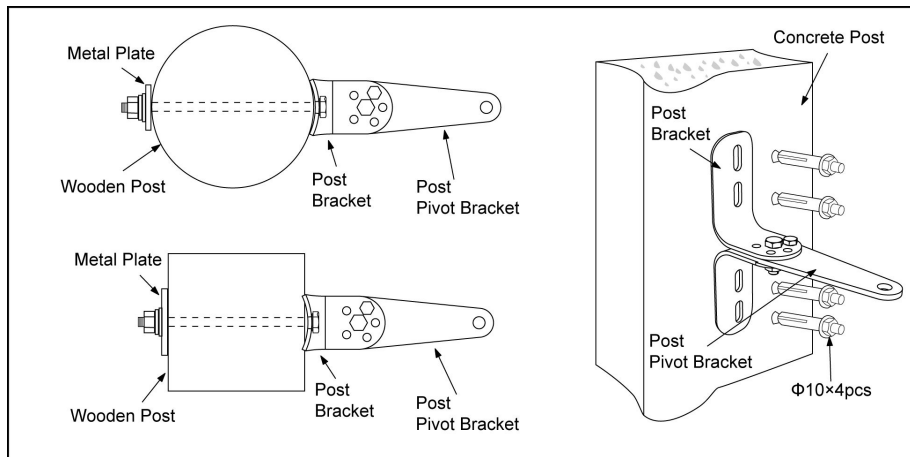

Both round and square post can be used because of the curved design of the post brackets. When mounting the post brackets, use bolts long enough to pass through the entire post. When mounting the post brackets to wooden posts, a larger-size washer or metal plate should be used between the bolts and the wooden post to ensure the stability of the fastening hardware when thrust is used.

If the gate post is smaller than 15 cm (6") diameter or square, it should be made of metal and set in cement to ensure the stability of the post.

## Determining the Position of Mounting Hardware

**NOTE:** The following steps are intended for **Pull-to-Open** gate installation only.

You will find a series of sizes from following chart to determine the proper mounting position

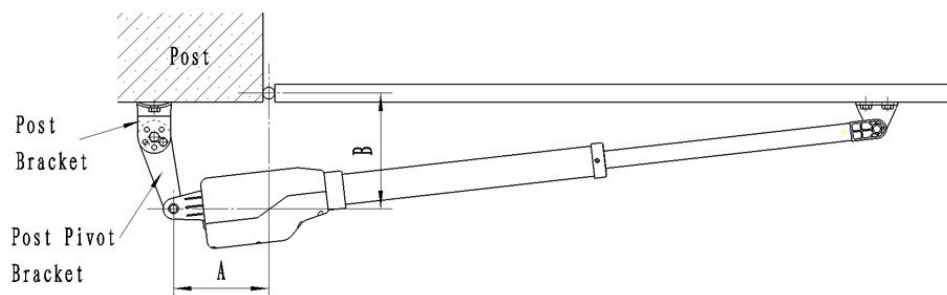

	A=8cm	A=9cm	A=10cm	A=11cm	A=12cm	A=13cm	A=14cm	A=15cm	A=16cm	A=17cm	A=18cm	A=19cm	A=20cm	A=21cm	A=22cm
B=19cm	90°	93°	96°	98°	101°	104°	106°	108°	110°	105°	102°	98°	95°	93°	91°
B=20cm	91°	93°	95°	98°	100°	103°	107°	110°	104°	99°	96°	94°	92°	90°	89°
B=21cm	91°	93°	95°	97°	100°	103°	106°	103°	99°	96°	93°	91°	89°	88°	
B=22cm	91°	94°	95°	97°	99°	101°	103°	98°	95°	92°	90°	89°	87°		
B=23cm	92°	94°	96°	98°	100°	103°	98°	94°	92°	90°	88°	86°			
B=24cm	90°	92°	95°	97°	99°	97°	93°	91°	88°	87°	85°				
B=25cm	90°	92°	94°	97°	96°	92°	90°	87°	85°	84°					
B=26cm	90°	92°	94°	95°	91°	88°	86°	84°							
B=27cm	90°	92°	95°	90°	87°	85°									
B=28cm	90°	93°	89°	86°	84°										

**NOTE:** Pay attention to the distance A when installing the opener. It **MUST** be longer than or at least equal to 8cm (3-1/4"). Otherwise, the opener force cannot be effective complete. The opener force is not notably related with the power of the opener.



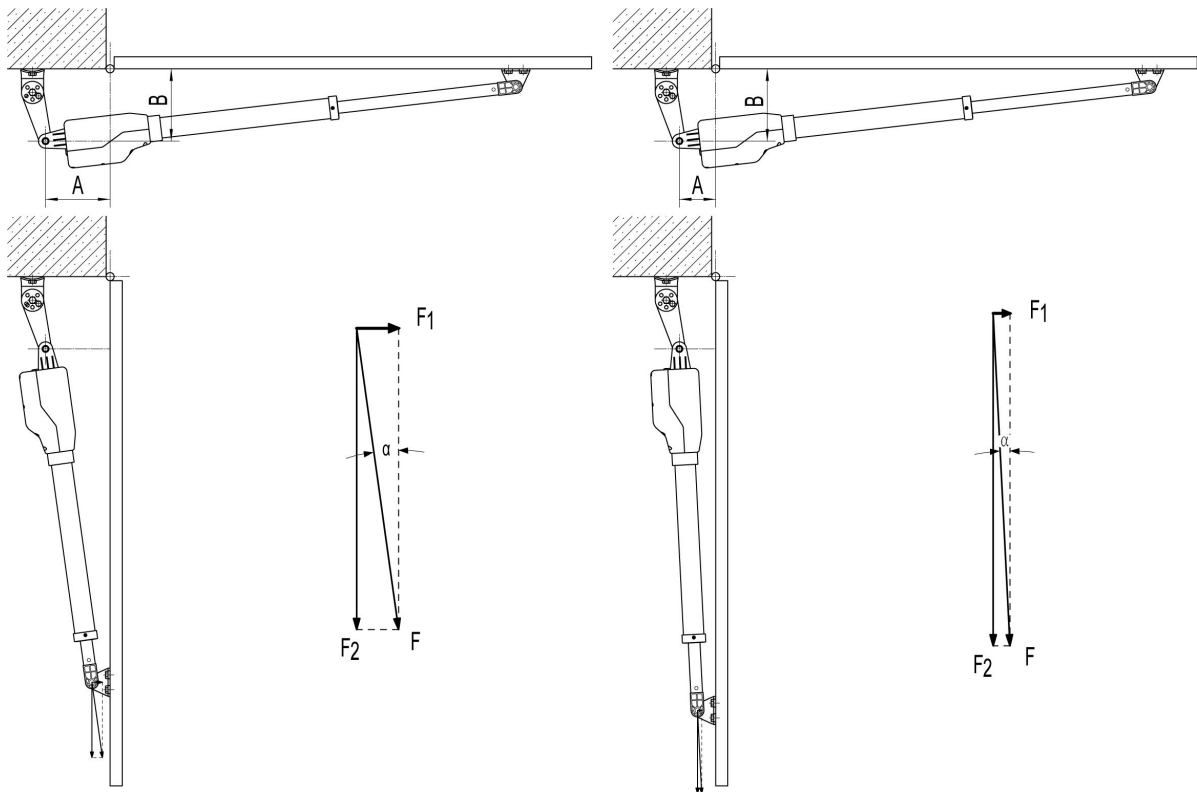

**TIPS**

- The opener force is composed of effective force  $F_1$  and idle force  $F_2$ . The values of force  $F_1$  and  $F_2$  vary with  $\alpha$  - the angle between the gate and axle of opener actuator.
- By the diagram in the right of the force  $F_1$  and  $\alpha$ , if the distance  $A$  is too short which leads to smaller  $\alpha$ , the  $F_1$  will not be big enough to overcome the stall force setting to push or pull the gate ideally.

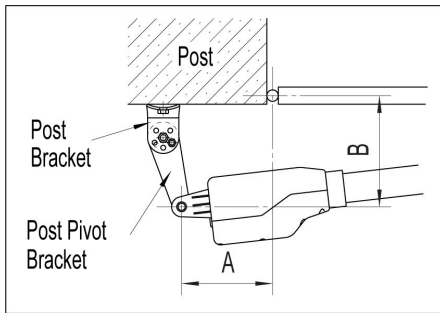
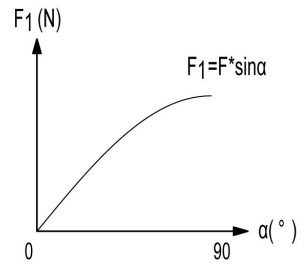

Fig.A < Recommend >

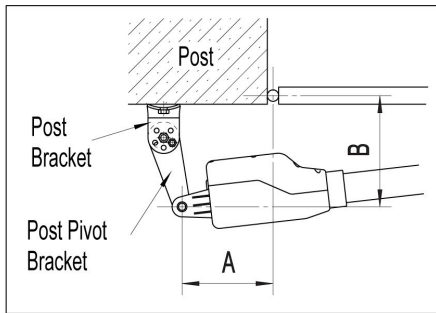
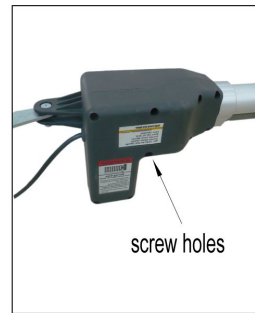

Fig.B < Not Recommend >



**NOTE: We recommend you keeping the actuator housing with screw holes outward as Fig. A for opener installation so as to have a bigger opening angle.**

### Step 1

Place the post pivot bracket between the two post brackets. Insert the M10 x 30 bolt through the center hole of the post bracket and post pivot bracket as shown. Place a  $\phi 10$  washer,  $\phi 10$  lock washer and M10 nut on the bottom of the bolt and hand tighten.

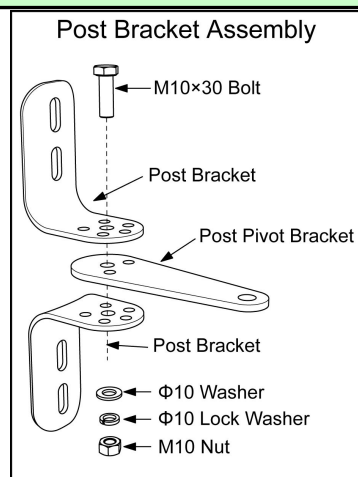

## Step 2

Attach the gate bracket and post bracket assembly to the opener by inserting a clevis pin. Secure the clevis pins using the hairpin clips.

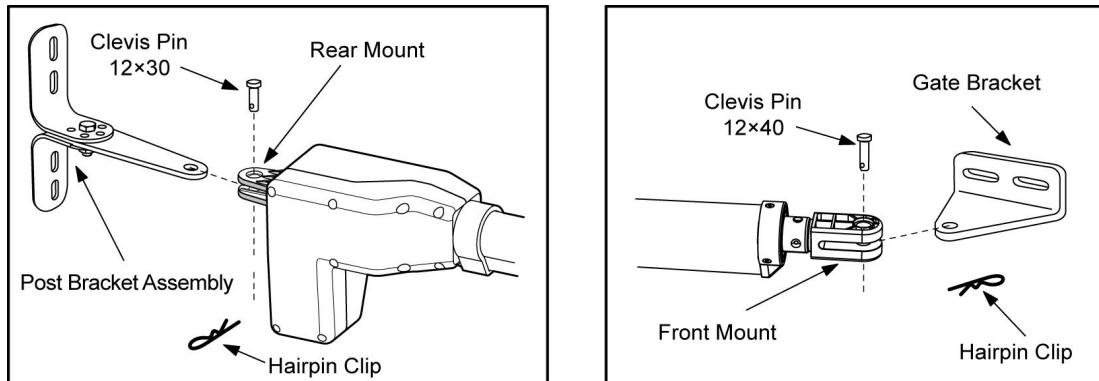

## Step 3

With the gate in its desired open position (from 0° to 100° from the gate closed position) and with the opener in its retracted position, place the opener with the gate bracket and post bracket assembly on the gate post and the gate. Position the gate bracket and the post bracket assembly so that the gate opener is level with the horizontal cross member of the gate. While holding the opener in the desired level position, temporarily secure it with two C-clamps.

**NOTE:** There is an emergency release design. Use the triangular key to release the opener, you can stretch the moving rod or retract it by hand to pull or push the front mount assembly. **Be sure that the openers are both locked before you prepare to activate your openers.** Other information please refer to content in page 24.

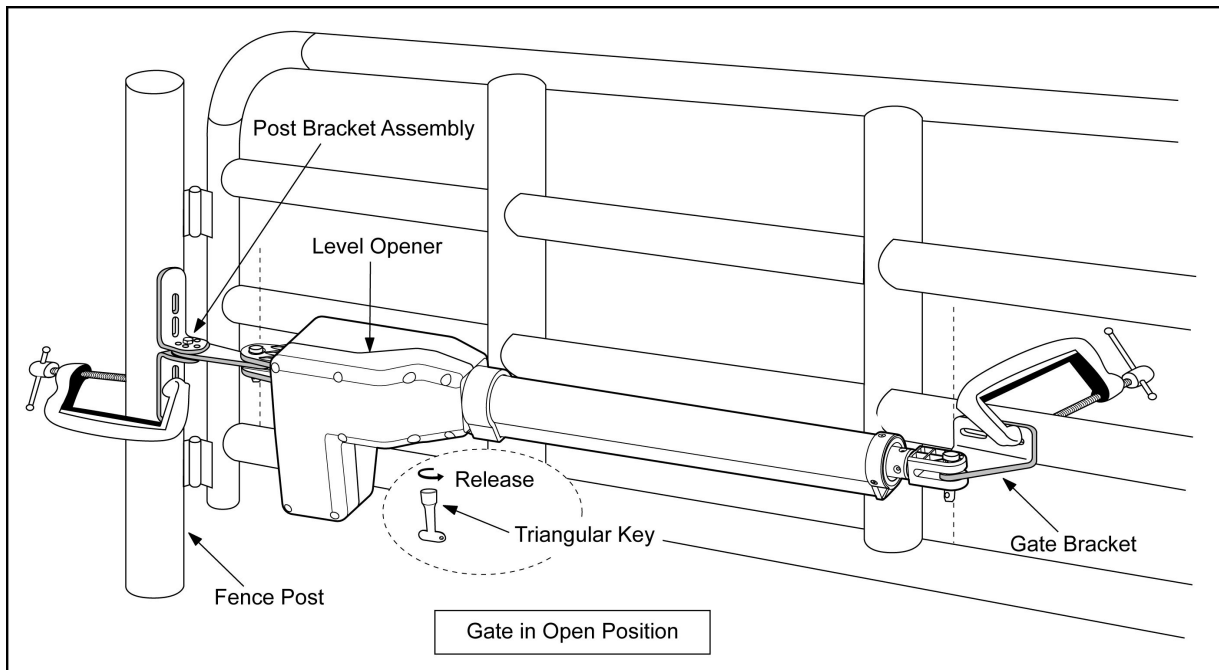

## Step 4

Determine the optimum position of the pivot bracket on the post bracket assembly by ensuring a minimum 2.5cm (1 inch) distance exists between the gate and the gate opener in both the gate-open and gate-closed positions. To ensure the minimum 2.5cm (1 inch) distance maintained in the gate-closed position, remove the clevis pin from the gate bracket while holding the gate opener, and then close the gate. Move the gate opener so as the gate bracket and the opener are aligned.

**NOTE:** Ensure the gate opener and the pivot brackets do not bind in the gate –open and gate –closed positions.

If you don't have enough distance, or the gate opener is binding on the post pivot bracket, you may move the post pivot bracket assembly slightly to the right or left to obtain the proper distance.

After you've identified the desired position of the pivot bracket, place the M8 x 30 bolt into the desired pivot on the post bracket.

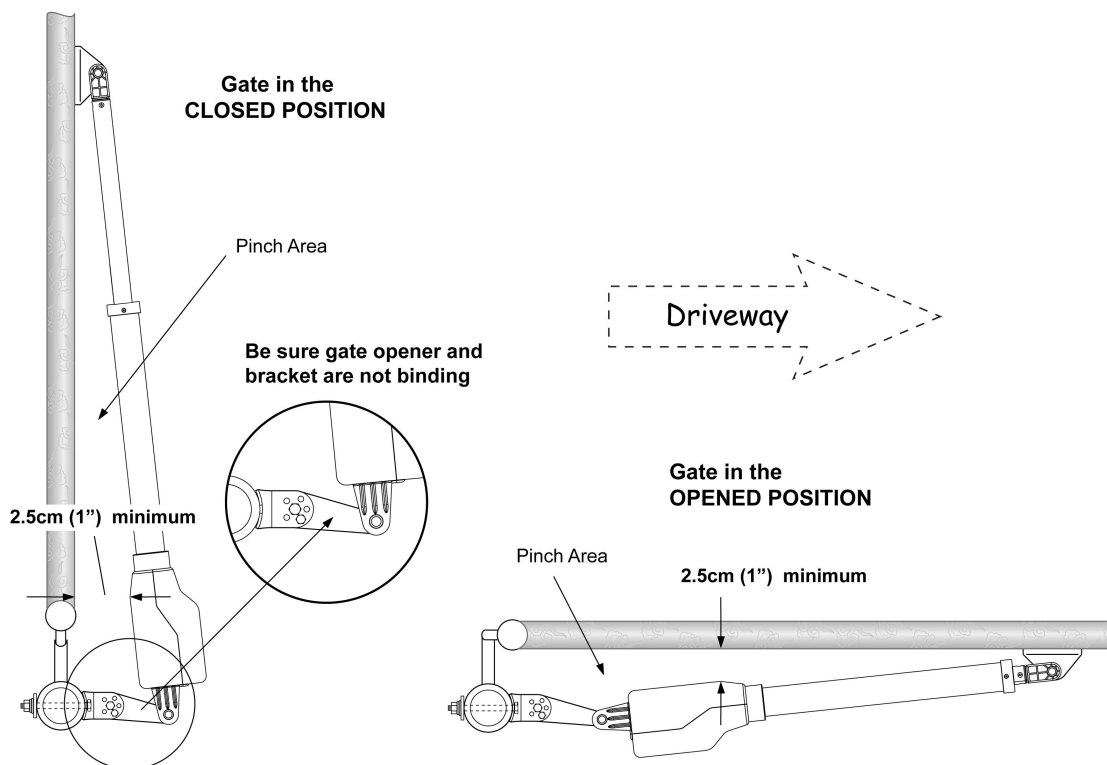

## Installing the Mounting Hardware

### Step 5

Sign the bolt-hole point on the gate bracket and gate. Do this by placing a punch or a sign in the middle of each bolt slot on the post bracket assemblies and the gate bracket. It allows slight adjustments to the post bracket. Then remove the post bracket and gate bracket by taking off the C-clamps.

## Step 6

Using a drill and a bit of  $\varnothing 10.5$ , drill holes through the post and the gate at the sign bolt hole point.

## Step 7

Attach the post bracket assemblies to the gate posts by inserting four M10 x 200 bolts through each post bracket assembly and the drilled holes in the gate post. Fasten each bolt with one  $\varnothing 10$  washer, one  $\varnothing 10$  lock washer, and one  $\varnothing 10$  nut.

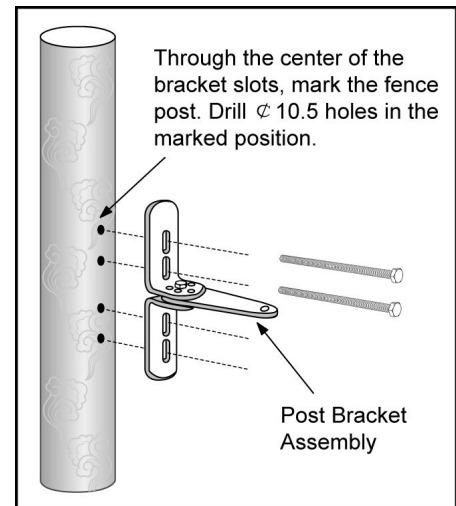

## Step 8

Attach the gate brackets to each gate by inserting two M10 x 75 bolts through the gate brackets and the drilled holes in the gates. Fasten each bolt with one  $\varnothing 10$  lock washer, and one  $\varnothing 10$  nut.

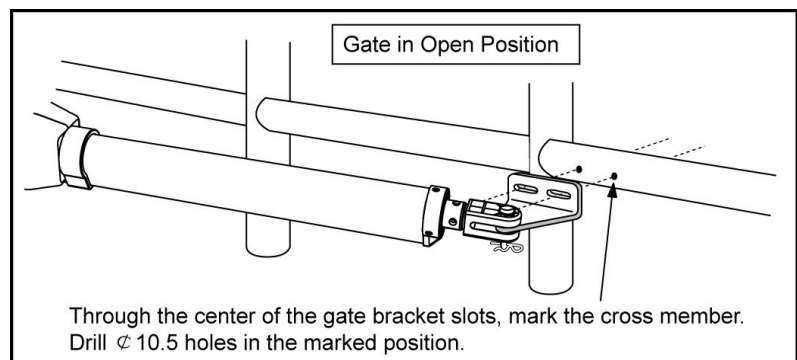

## Step 9

Cut all parts of bolt which are extending beyond the tightened nuts by saw.

# Installing of the Opener

## Step 10

Fasten the opener to the previously bolted post bracket assembly with the four clevis pins provided. Insert one clevis pin through the gate opener and the gate bracket. Insert the other clevis pin through the gate opener and the post bracket assembly. Secure the clevis pins with the two hairpin clips.

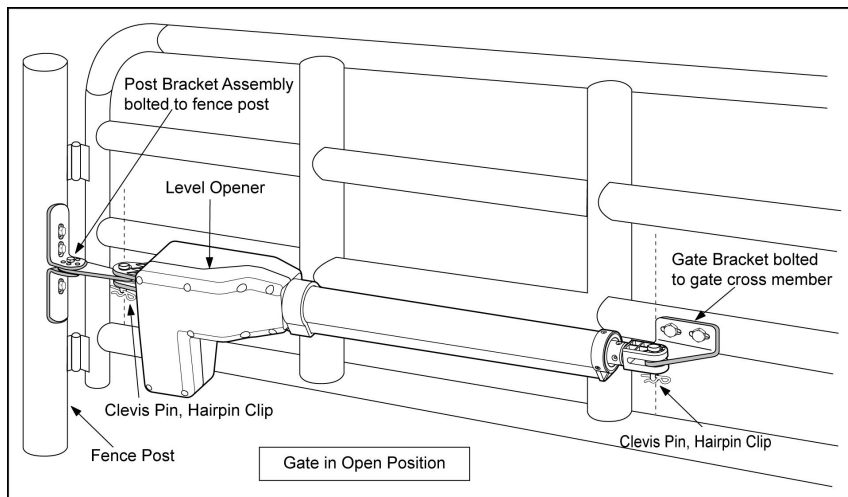

## Mounting the Control Box

### Step 1

To install the control box use the deck screws (not provided). Ensure the control box is installed in a secure surface and at least 100 cm (40 inches) above the ground to protect it from rain, snow, etc. which probably cause damage to the control box.



**Warning:** Before connecting the AC power cable to the control box, check the plug of power cable is disconnected from AC power socket.

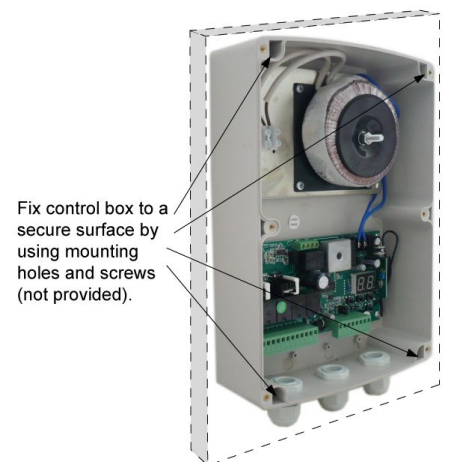

### Step 2

Insert the power cable and cable of the first gate opener through the front strain relief and into the control box by loosening the strain relief screw located in the leftmost of outside bottom of the control box and feeding the cables into the control box. Check the length of cables is long enough to their respective terminal block in control box. Retighten the sealing nut so that cables are well locked.

Strain Relief	
	Lock Nut
	Hub
	Sealing Nut

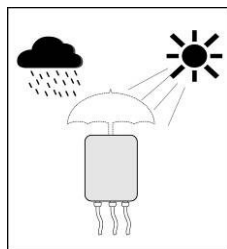

**CAUTION:** Install the Control Box in a well ventilated place protected against rain and sunlight.

**NOTE:** It is strongly suggested that the control box should be mounted in the side of Master Gate (Gate 1), so that the electric lock can be installed correctly and work properly (See Page 9).

### Step 3

Insert the cable of the second gate opener and alarm lamp cables into the control box through middle strain relief. Then repeat step 2.

### Step 4

Insert other cables into the control box through rightmost strain relief. Then repeat step 2.

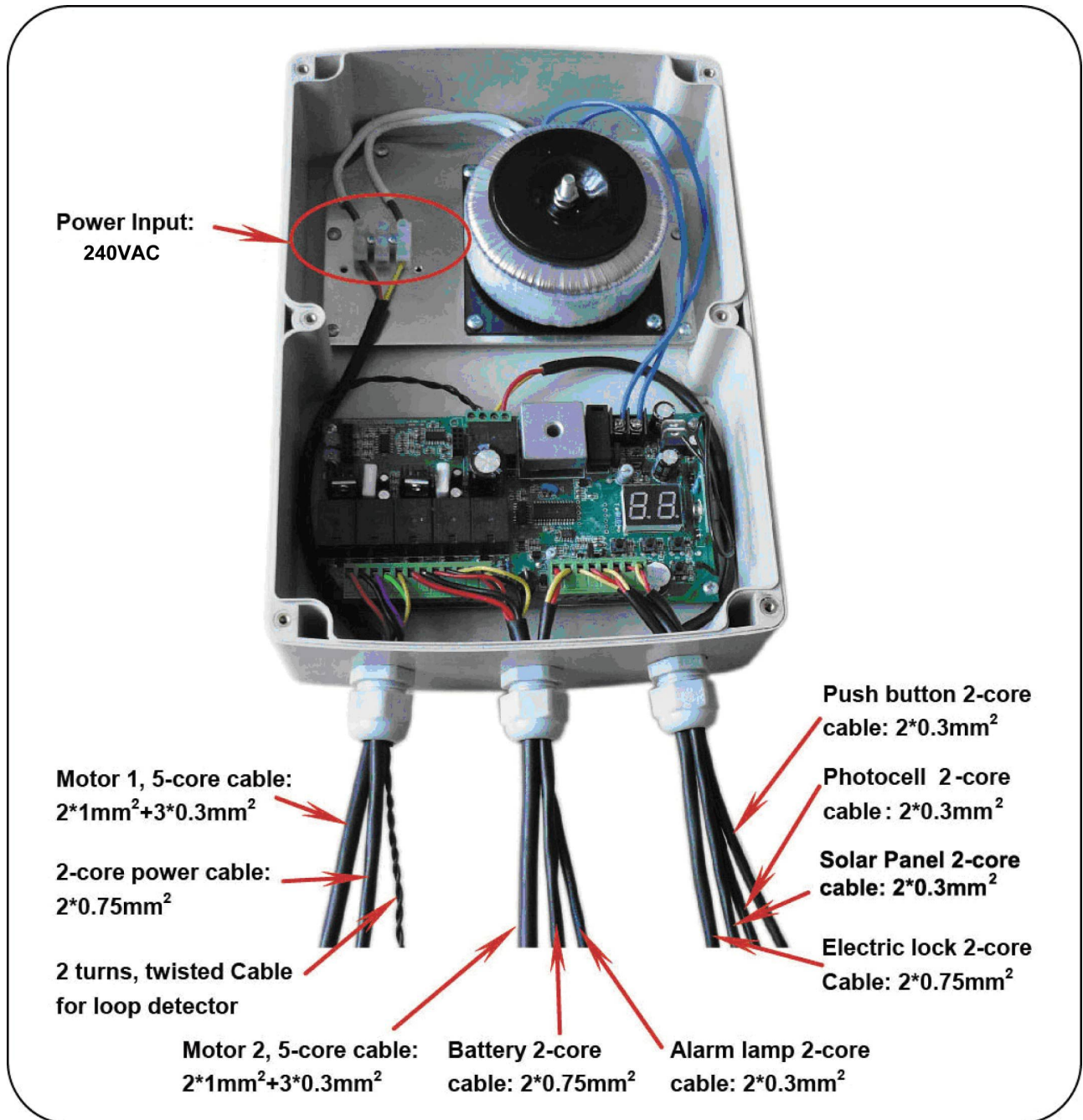

**NOTE:** Only motor cables (1.5m length) are provided. Other cables are subject to site installation requirement and not provided.

**CAUTION:** Make sure the cable outlet hole in the Control Box is always down during installation so as to drain off the water.



# Connecting of the control board

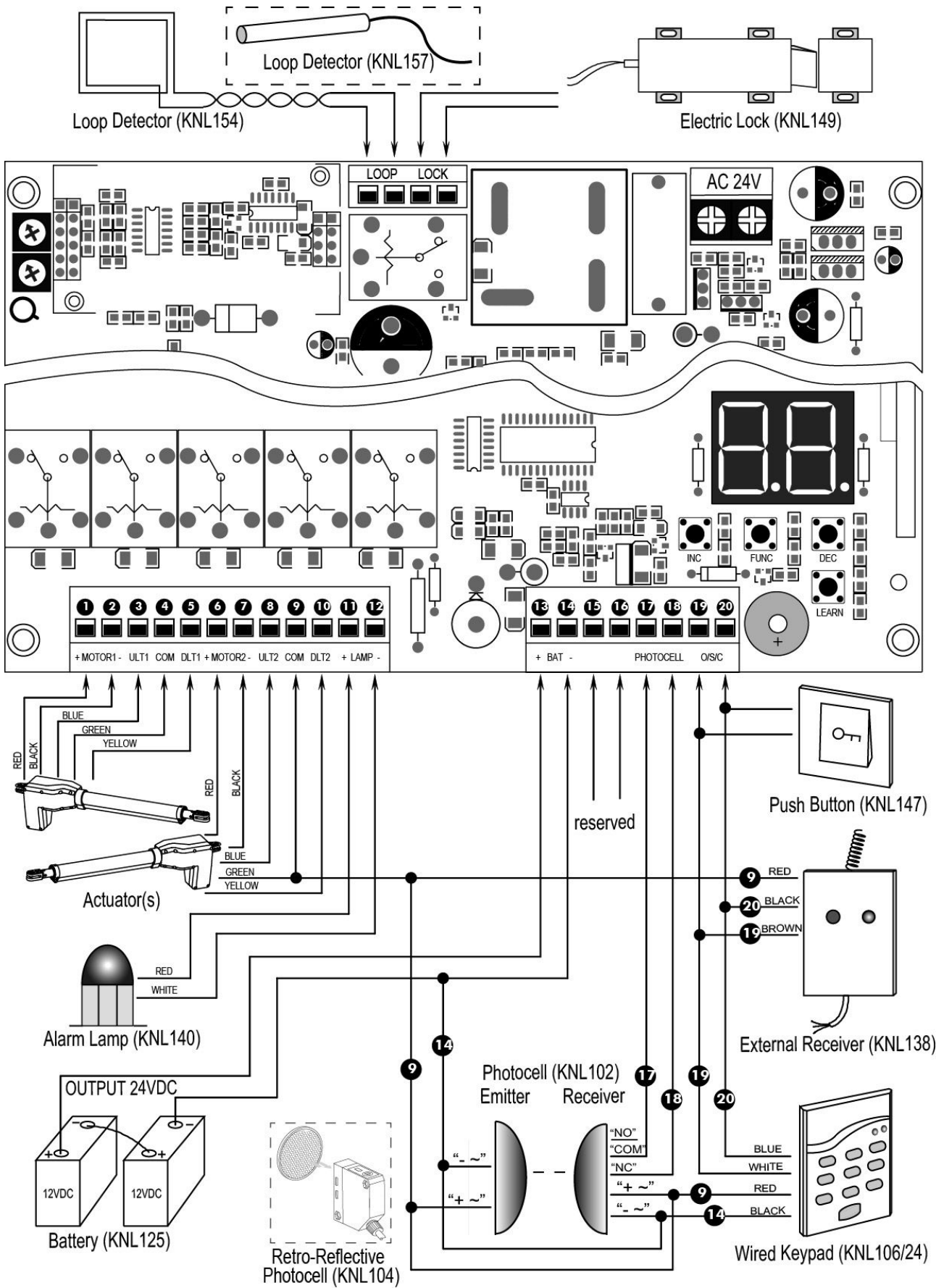

## Actuator 1

Insert the stripped cable wires into the appropriate terminals on the opener terminals block. The **red** wire should be inserted into the “**MOTOR1+**” terminal, the **black** wire into “**MOTOR1-**”, the **blue** wire into **ULT1**, the **green** wire into **COM**, and the **yellow** wire into **DLT1** terminal.

## Actuator 2

Similar as the connection of **Actuator 1**, insert the stripped cable wires into the appropriate terminals on the opener terminals block. The **red** wire should be inserted into the **MOTOR2+** terminal, the **black** wire into **MOTOR2-**, the **blue** wire into **ULT2**, the **green** wire into **COM**, and the **yellow** wire into **DLT2** terminal.

**NOTE:** It is recommended that Gate Opener 1 is installed in the Master Gate, and Gate Opener 2 is installed in the Slave Gate.

## Alarm Lamp (optional)

The red wire of the alarm lamp should be inserted into either **LAMP (#11)** terminal, the white wire into the other one (**#12**).

## Back-up Battery (optional)

The “**24V+**” of the battery should be wired to the **BAT+ (#13)** terminal, “**24V-**” should be wired to “**BAT-**” (**#14**) terminal.

**Recommend strongly to use the controller KNL118 (WA4004 ) to connect Battery with battery’s Terminal of control board if the battery is used as the primary power supply in system (such as SOL PLUS KIT). Please refer to the user manual of control KNL118 (WA4004 ) separately.**

## Photocell Beam System (PBS) (optional)

Use a 2-core cable to connect the “**- ~**” terminal of the photocell’s emitter to the “**14**” terminal, the “**+ ~**” terminal to the “**9**” terminal. Also the “**- ~**” and “**+ ~**” terminals of the photocell’s receiver should be connected to the “**16**” and “**17**” terminals in parallel.

Use another 2-core cable to connect the “**COM**” terminal of the receiver to the “**17**” terminal, the “**NC**” terminal to the “**18**” terminal.

## Push Button (optional)

The red wire should be inserted into either **O/S/C** terminal, the white wire into the other one.

## Loop Detector (optional)

First insert the **LOOP DETECTOR BOARD** into the **CONTROL BOARD**, and then connect the twisted-pair to the “**LOOP**” terminal.

## Electric Lock (optional)

The electric lock should be wired to the “**LOCK**” terminal.

## External Receiver (optional)

The **BROWN** wire of the external receiver should be connected into the “**19**” terminal.

The **BLACK** wire of the external receiver should be connected into the “**20**” terminal.

The **RED** wire of the external receiver should be connected into the “**9**” terminal.



## Wired Keypad (24VDC) (optional)

The **RED** wire of the wired keypad should be connected into the “9” terminal.  
The **BLACK** wire of the wired keypad should be connected into the “14” terminal.  
The **WHITE** wire of the wired keypad should be connected into the “19” terminal.  
The **BLUE** wire of the wired keypad should be connected into the “20” terminal.

## Solar Panel (optional)

Please refer to the manual instruction of solar panel and controller separated.

## How to learn or erase the remote

### Learn the remote

Press and release the learn button, the **LED** will display “Ln”, then press the key in the remote twice in 2 seconds, the **LED** will flash “Ln” for 4 seconds then back to “- -”. Now the remote has been learnt successfully.



**WARNING:** Activate the opener only when gate is in full view, free of obstruction and properly adjusted. No one should enter or leave gate area while gate is in motion. Do not allow children to operate push button or remote. Do not allow children to play near the door.  
Your swing gate opener receiver and remote control transmitter are set to a matching code. If you purchase additional remote controls, the gate opener must be programmed to accept the new remote code.

### Erase all the remote codes

Press and hold the learn button until the **LED** display back to “- -”. Now all remote codes have been erased.

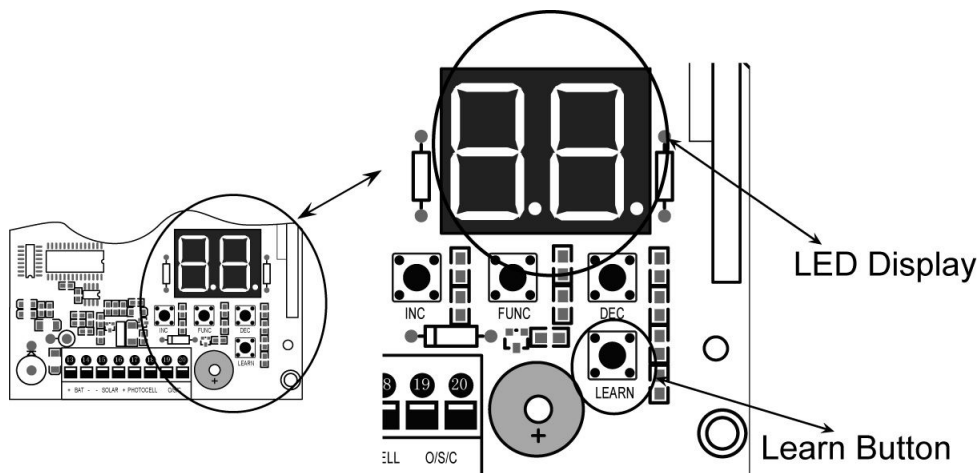

**Caution:** If you lose one of any remote control, please learn all other remote controls to have a new code for safety.

# Setting of the Control Board

1. Check again for completed and correct assembly of your swing gate opener and gate. Plug the Power Grounded Cord into the nearest AC outlet. The Digital Display on the Control Board will flash with “- -”. The unit is in standby.

## 2. Single/Dual Gate Set

Press and hold the “FUNC” button for more than 4 seconds. The Digital Display will indicate “P1”. Gate opener is on the SINGLE/DUAL Gate setting. Press the “INC” and “DEC” buttons respectively to following modes:

“01” shown in Digital Display, it is Single Actuator 1 (Gate 1) mode. “10” shown in Digital Display, it is Single Actuator 2 (Gate 2) mode. “11” shown in Digital Display, it is Dual actuator mode.

Press the “FUNC” button to store the data when the single or dual gate is chosen. The Digital Display will indicate “P2”. Now single/dual gate set is finished.

(Factory set is “11”)

## 3. Master/Slave Gate Set

When Digital Display indicates “P2”, the gate opener is on the Master/Slave Gate Setting. Press the “INC” and “DEC” Buttons respectively to follow modes:

“01” shown in Digital Display, which means Gate Opener 1 (right-hand side) as Master one

“10” shown in Digital Display, which means Gate Opener 2 (left-hand side) as Master one

Press the “FUNC” button to store the data when the master/slave gate is chosen. The Digital Display will indicate “P3”. Now Master/Slave Gate Set is finished.

(Factory set is “01”)

## 4. Set the Open Interval between Master and Slave Gate

When the Digital Display indicates “P3”, the gate opener is on the Open Interval between Master/Slave Gate Setting.

The open interval can be adjusted by pressing the “INC” and “DEC” Buttons respectively. The Digital Display will show “0”-“9”, which indicates the interval time “0” means the Master and Slave gates open simultaneously. “1” means the Master Gate starts to open 1 second before Slave gate starts to open. Max. open interval is 9 seconds. Each time you press and release the “INC” button, the figure increases by 1, and the Master gate starts to open 1 more second earlier. Each time you press and release the “DEC” button, the figure decreases by 1, and the interval decreases by 1 second.

(Factory set is 3 seconds)

Press the “FUNC” button to store the data when the open interval is set. The Digital Display will indicate “P4”. Now Open Interval Set is finished.

## 5. Set the Close Interval between Master and Slave Gate

When the Digital Display indicates “P4”, the gate opener is on the Close Interval between Master/Slave Gate Setting.

The close interval can be adjusted by pressing the “INC” and “DEC” buttons respectively. The Digital Display will show “0”-“9”, which indicates the interval time “0” means the Master and Slave gates open simultaneously. “1” means the Slave Gate starts to close 1 second before Master gate starts to close. Maximum close interval is 9 seconds. Each time you press and release the “INC” button, the figure increases by 1, and the Slave gate starts to close 1 more second earlier. Each time you press and release the “DEC” button, the figure decreases by 1, and the interval decreases by 1 second.

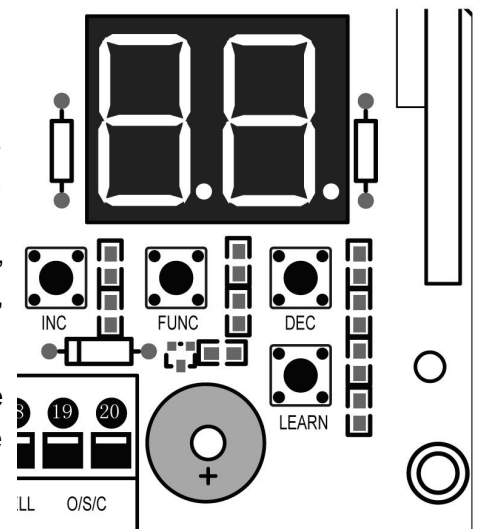

(Factory set is 3 seconds)

Press the “FUNC” button to store the data when the close interval is set. The Digital Display will indicate “P5”. Now Close Interval Set is finished.

## 6. Adjust the Obstruction Sensitivity/Stall Force

When the Digital Display indicates “P5”, the gate opener is on the Stall Force Adjustment.

Without a properly installed safety reversal system, person (particularly small children) could be SERIOUSLY INJURED or KILLED by a closing gate.

\*Too much force on gate will interfere with proper operation of safety reversal system.

\*NEVER increase force beyond minimum amount required to close gate.

\*NEVER use force adjustments to compensate for a binding or sticking gate.

\* If one control (force or travel limits) is adjusted, the other control may also need adjustment.

\* After ANY adjustments are made, the safety reversal system MUST be tested. Gate MUST BE TESTED. Gate MUST reverse on contact with a rigid object.

The opener is equipped with an obstruction sensing feature. If the gate encounters an obstruction the opener will automatically reverse direction and stop. Based on the length and weight of the gate it may be necessary to make force adjustments. The force adjustment should be high enough that small objects such as branches or wind will not cause nuisance interruptions but low enough to prevent serious injury to a person or a vehicle.

### 6-a Adjust Stall Force of Gate Opener 1

Now we adjust the stall force of gate 1

The stall force of gate opener1 is adjusted by pressing “INC” and “DEC” buttons respectively. The Digital Display will show “1”-“9” which indicates the stall force levels. “1” means the minimum force, and “9” is the maximum force. Each time you press and release the “INC” button, the figure increase by 1, and the force increases to a higher level. Each time you press and release the “DEC” button, the figure decreases by 1, and the force decreases to a lower level. Press “FUNC” to store the data. The Digital Display will indicate “P6”. Now stall force of gate opener 1 is finished.

(Factory set is Level 3)

### 6-b Adjust Stall Force of Gate Opener 2

When the Digital Display indicates “P6”.you can adjust force of gate opener 2.

Please perform the same procedure as gate opener 1 (6-a).

Press the “FUNC” button to store the data when stall force of gate opener 2 is set. Then “P7” will be shown on the Digital Display.

**NOTE:** You may need to increase the stall force in cold weather due to increased resistance from gate hinges. The gate opener’s opening/closing force is adjusted automatically according to stall force adjustment.

## 7. Adjust the Max Motor Running Time (MRT) of the MOTOR for gate opener

The maximum running time of the MOTOR can be set to make the motor stop running after a specified period even if the limit switch is invalid or the clutch is detached.

### 7-a. Adjust the MRT of MOTOR1

When the Digital Display indicates “P7”, you can adjust the **MRT** of MOTOR1.

The **MRT** of MOTOR1 is adjusted by pressing “INC” and “DEC” buttons respectively. The Digital Display will show “01”-“50” which indicates the **MRT** of MOTOR1 from 1 to 50 seconds.

You can hold pressing the “INC” or “DEC” button for more than 1 second to speed up the setting. Press the “FUNC” button to store the data when you finish setting. The Digital Display will indicate “P8”.

(Factory default setting is “40” seconds)

### **7-b. Adjust the MRT of MOTOR2**

When the Digital Display indicates “P8”, you can adjust the **MRT** of MOTOR2.

Please perform the same procedure as adjusting MOTOR1 (7-a).

Press the “FUNC” button to store the data when you finish setting. The Digital Display will indicate “P9”.

Now MOTOR2 adjustment is finished.

### **8. Set the Safety Photocell Beam System (PBS) (Optional)**

When the Digital Display indicates “P9”, the gate opener enters PBS set mode.

You can press and release the “INC” or “DEC” button to set or shut off the PBS function. The Digital Display indicates “11”, the PBS is available. The Digital Display indicates “00”, the PBS is null.

**Note:** If the “11” is be set, the gate opener won't work until the PBS system is equipped. The PBS system works only when gate opener is closing. The gate opener will return to its open position when the obstruction blocks the beam from photo eye.

Press the “FUNC” button to store the data when the PBS is set. The Digital Display will indicate “PA”.

(Factory set is “00”)

### **9. Set the Automatic Closing Time**

When the Digital Display indicates “PA”, the gate opener enters into the setting of automatic closing time mode. Press and release the “INC” or “DEC” button, the Digital Display will show a “01”-“99” which indicates the current automatic closing time. The minimum time is 1 second, 99 seconds maximum. Each time you press and release the “INC” button, the figure increases by 1, and the timing increases by 1 second. Each time you press and release the “DEC” button, the figure decreases by 1, and the timing decreases by 1 second. When the timing is “00”, the automatic closing function is shut off and the gate will stay open.

(Factory set is 60 seconds)

Press the “FUNC” button to store the data when the desired automatic closing time is set. The Digital Display will indicate “Pb”

### **10. Set the Period of Soft Start**

When the Digital Display indicates “Pb”, the gate opener is ready for setting period of soft start.

You can press the “INC” or “DEC” button to set the period of soft start. There is 1-9 seconds available in setting. Press the “FUNC” button to store the data when the period is set. The Digital Display will indicate “PC”.

(Factory set is 3 seconds)

### **11. Set the Fast Running Period (FRP) to Achieve Soft Stop Function (SPP)**

When the Digital Display indicates “PC”, the Fast Running Period for opening or closing gate is adjustable by pressing “INC” and “DEC” buttons respectively, and the Soft Stop Function is achieved simultaneously.

The Soft Stop means the gate opener runs at slow speed during the last period before the gate completely closes. The Soft Stop Period is unavailable by direct adjust but available through adjusting the Fast Running Period.

There are two running speeds designed in program, i.e. Fast Running Speed and Soft Running Speed. The Fast Running Period is adjustable from 1 to 28 sec. Factory default setting is 15 sec.

Since the GATE OPENING OR CLOSING RUNNING PERIOD (GRP) = SOFT START PERIOD (STP) + FAST RUNNING PERIOD (FRP) + SOFT STOP PERIOD (SPP), the SPP could be extended by shortening the FRP when the GRP and STP are fixed. In other words,  $SPP = GRP - STP - FRP$ .

Similarly, the Soft Stop Period (SPP) can be shortened through extending the Fast Running Period (FRP).

**E.g.** When the Soft Start Period (STP) is set at 3 sec, and the GRP is 23 sec, how can we get 4 sec of Soft Stop Period (SPP) to meet the requirement? The answer is clear, i.e. we may set the Fast Running Period (FRP) at 16 sec ( $23 - 3 - 4 = 16$  sec).

## 12. Return to Factory Set

When the Digital Display indicates “Pd”, press and release the “INC” or “DEC” button. All data will return to factory set, the Digital Display indicates “dF”.

13. If all of data is set and no other change needed, press “FUNC” Button. “- -” appears on the Digital Display, and the opener enters standby mode.

## Indicate Illustration on the Digital Display When Gate Opener is Running

The left image on Digital Display symbolizes motor of gate opener 1 when the gate opener is running. The right image on Digital Display symbolizes motor of gate opener 2.

When the motor is run to gate -open direction or gate -close direction, the image on Digital Display indicates “n” or “u” respectively.

When the motor is not running, the Digital Display indicates “- -”.

When Gate Opener 2 is set as Master gate (i.e. when “10” indicated at P2 set mode in the Control Board), the Digital Display flashes “-n” before the gate completely opens and closes.

## Adjusting the Limit Switch

### Step 13

#### Adjusting the Limit Switch of Actuator 1

The position of Limit Switch A was fixed in factory, do not adjust it again.

Plug on the power to running gate opener, use a screwdriver to loose the screw of Limit Switch B, slide Limit Switch B to the desired closed position and fix it.

Limit setting for Gate 1 is finished now.

**NOTE:** Always place the magnetic ring between the Limit Switch A and B.

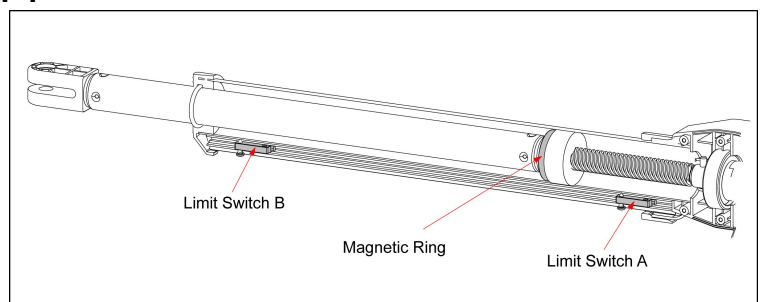

### Step 14

#### Adjusting the Limit Switch of Actuator 2

The position of Limit Switch C was fixed in factory, do not adjust it again.

Use a screwdriver to loose the screw of Limit Switch D, slide Limit Switch D to the desired closed position and fix it.

Limit setting for Gate 2 is finished.

**NOTE:** Always place the magnetic ring

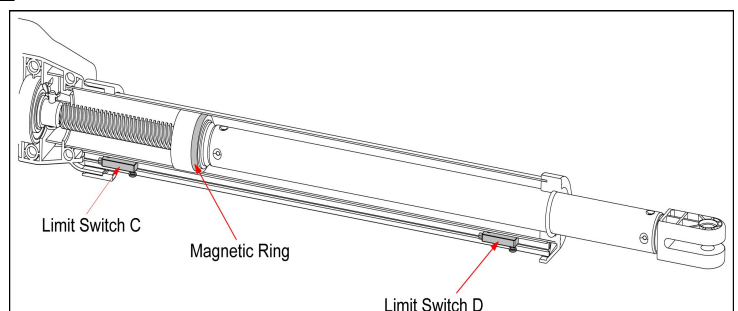

between the Limit Switch C and D.

**NOTE:** The magnetic ring in the moving rod can be manually placed between both Limit Switches in each actuator. See Page 24 Emergency Release.

## How to Operate

The user may operate the opener once all adjustment setting is finished.

With the gate in its closed position, press and release the remote control, the gate will move to the programmed opening position and stop.

With the gate in its opened position, press and release the remote control, the gate will move to the programmed closing position and stop.

While the gate is moving, press and release the remote control, the gate will stop moving immediately. The next command from the remote will reverse the gate direction and the gate will stop at its programmed opening/closing position.

The gate will stop in case of obstruction during opening. The command from the remote control will reverse the gate direction and the gate will stop at its programmed closing position.

The gate will reverse in case of obstruction or stall force during closing, and it will move to the programmed opening position.

**NOTE:** The Obstruction Sensitivity /Stall Force is adjustable in 9 levels.

## Emergency Release

In case of the system failure or power cut-off, the gate can be manually opened.

Insert the triangular key inside the triangular plug located on the bottom of actuator body, and then turn clockwise (left actuator) or counter-clockwise (right actuator) till the stop. Motors shall be released. The inverse operation restores the gate automation.



## Installation for Push-to-Open Gates

**⚠** Ensure the gate does not open into public areas.

In a Push-to-Open installation, gate opens out from the property. A Push-To-Open Bracket (PSO part) is required to be used for each gate. The gate is in the closed position during the opener is installed.

### Step 1

Place the PSO bracket between the two post brackets. Insert the M10x30 bolt through the center hole of the post bracket and PSO bracket as shown. Place a  $\varnothing$  10 washer,  $\varnothing$  10 lock washer and M10 nut on the bottom of the bolt and hand tighten.

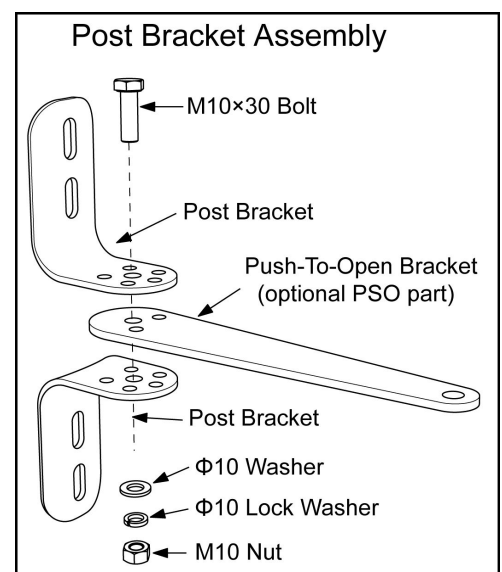

## Step 2

Attach the gate bracket and post bracket assembly to the opener by inserting a clevis pin. Secure the clevis pins using the hairpin clips.

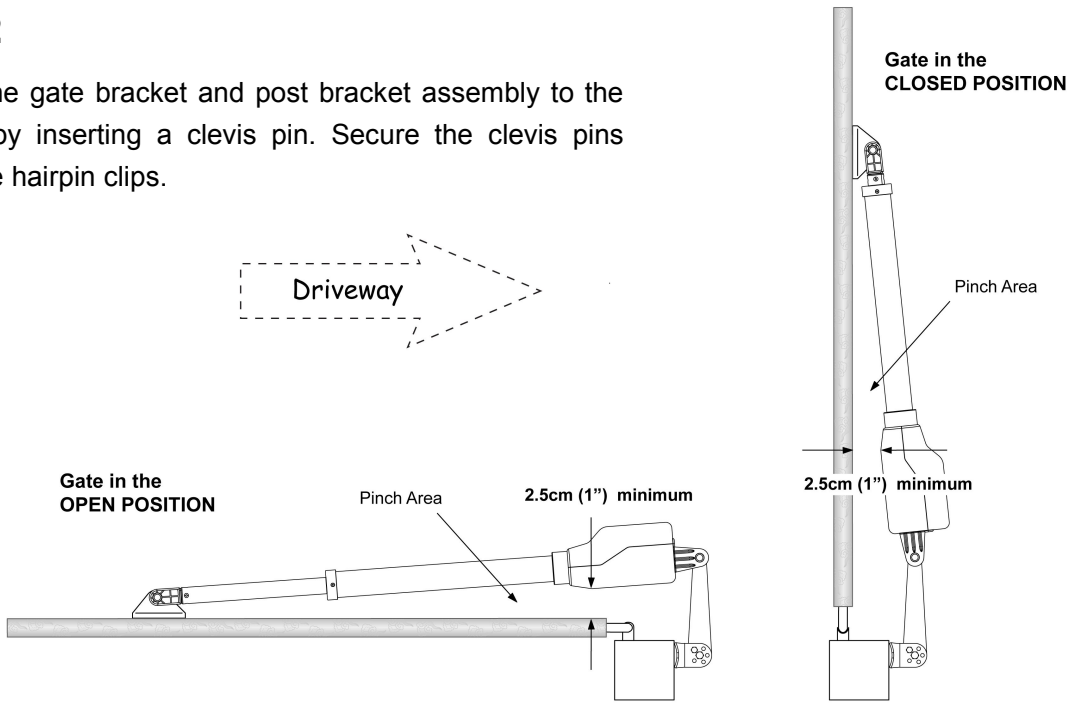

## Step 3

With the gate in closed position and with the opener in their retracted position, place the opener with the gate bracket and post bracket assembly on to the gate post and the gate. Position the gate bracket and the post bracket assembly so that the gate opener is level with the horizontal cross member of the gate. While holding the opener in the desired level position, temporarily secure with two C-clamps.

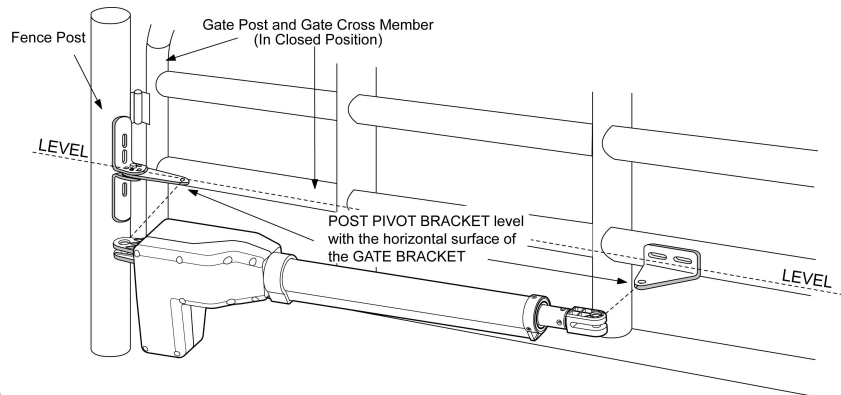

## Step 4 to Step 9

Repeat the Step 4-9 in P 13-14.

## Step 10

The motors' power wires and limit wires connection by "Push to Open" is different from the connection by "Pull to Open". So motor 1 and motor 2 wires should be connected to the control box as the instruction in the right, not according to the instructions in Page 17.

The **black** wire should be inserted into the Motor+ terminal, the **red** wire should be inserted into the Motor- terminal, the **yellow** wire into ULT1 terminal, the **blue** wire into DLT1 terminal and the **green** wire is still into COM terminal.

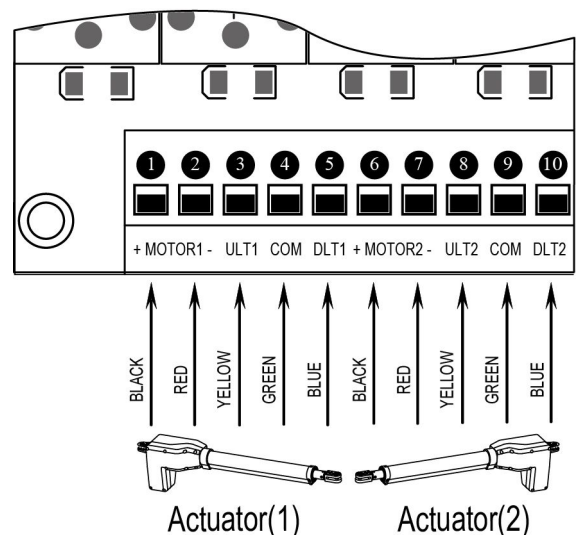



# Maintenance

 **Warning:** *Disconnect power before servicing.*

1. Using a clean, dry cloth, wipe the gate opener shaft, and then apply a silicone spray to reduce its friction. In cold climates where temperatures reach 1°C (30°F) or less, spray silicone on the actuator every 4~6 weeks to prevent freeze up.
2. Regularly check gate hinges to make sure gate is swinging smoothly and freely. Grease hinges if needed.
3. Check your installation periodically, as hardware and posts will shift. Brackets may need to be adjusted or hardware may need to be tightened.
4. Maintain the area around your gate. Keep the areas free of objects that can prevent the gate swinging freely.

## **NOTES:**

1. *Inspection and service should always be performed anytime a malfunction is observed or suspected.*
2. *It is suggested that while at the site voltage readings be taken at the operator. Using a Digital Voltmeter, verify that the incoming voltage to the opener it is within ten percent of the opener's rating.*
3. *Refer to Page 22 for instructions on how to check gate force and sensitivity adjustments.*

# Trouble Shooting

1. Opener does not run. Digital Display indicator is not on.
  - Check if all motor are properly connected and color coded. Make sure the AC input is connected.
  - Check if the fuse in control board is bad.
2. Opener powers up but does not run.
  - Arm cable loose or disconnected. Verify that all of the wires going to the arm are secure and that the connector is properly mated to the header.
  - Arm is incorrectly installed. Disconnect the motor housing from the arm and verify that the arm moves freely.
  - Gate is excessively heavy or hinges are bad. Verify that the gate is within the ratings for this product. Disconnect the arms and verify that both gates swing easily. Lubricate or replace hinges as necessary.
  - Bad control board. Call technical support for help with replacement parts.
3. Gate stops immediately after it starts moving.
  - Obstruction sensed. Check safety devices and gate for obstructions.
  - Force set too low. Adjust FORCE setting until gate completes a full open/close cycle without stop. The force setting may need to be adjusted in cold weather, as the gate will not move freely.
  - Check if the MRT period is too short. Refer to page 22.
  - Incorrect power.
4. Gate opens but does not close.
  - Photocell (PBS) is set in Control Board but is not equipped (optional). Please cancel the PBS set. Refer to page 23.
  - Obstruction blocking close photo eyes, Check eyes for alignment and verify all connections and operation for safety devices.



5. Gate ignores the limit switches

- Check that the limit switch is not faulty
- Check that wires to the limit switch are not shorted.
- Ensure that the motor cable is away from sources of electrical interference, such as electric fences, power lines etc.

6. Gate opens, closes or stops on its own

- Ensure that the key for manual release is in the lock position. Refer to page 25.



**According to Waste of Electrical and Electronic Equipment (WEEE) directive, WEEE should be separately collected and treated. If at any time in future you need to dispose of this product please do NOT dispose of this product with household waste. Please send this product to WEEE collecting points where available.**

## Quick-Setting Guide

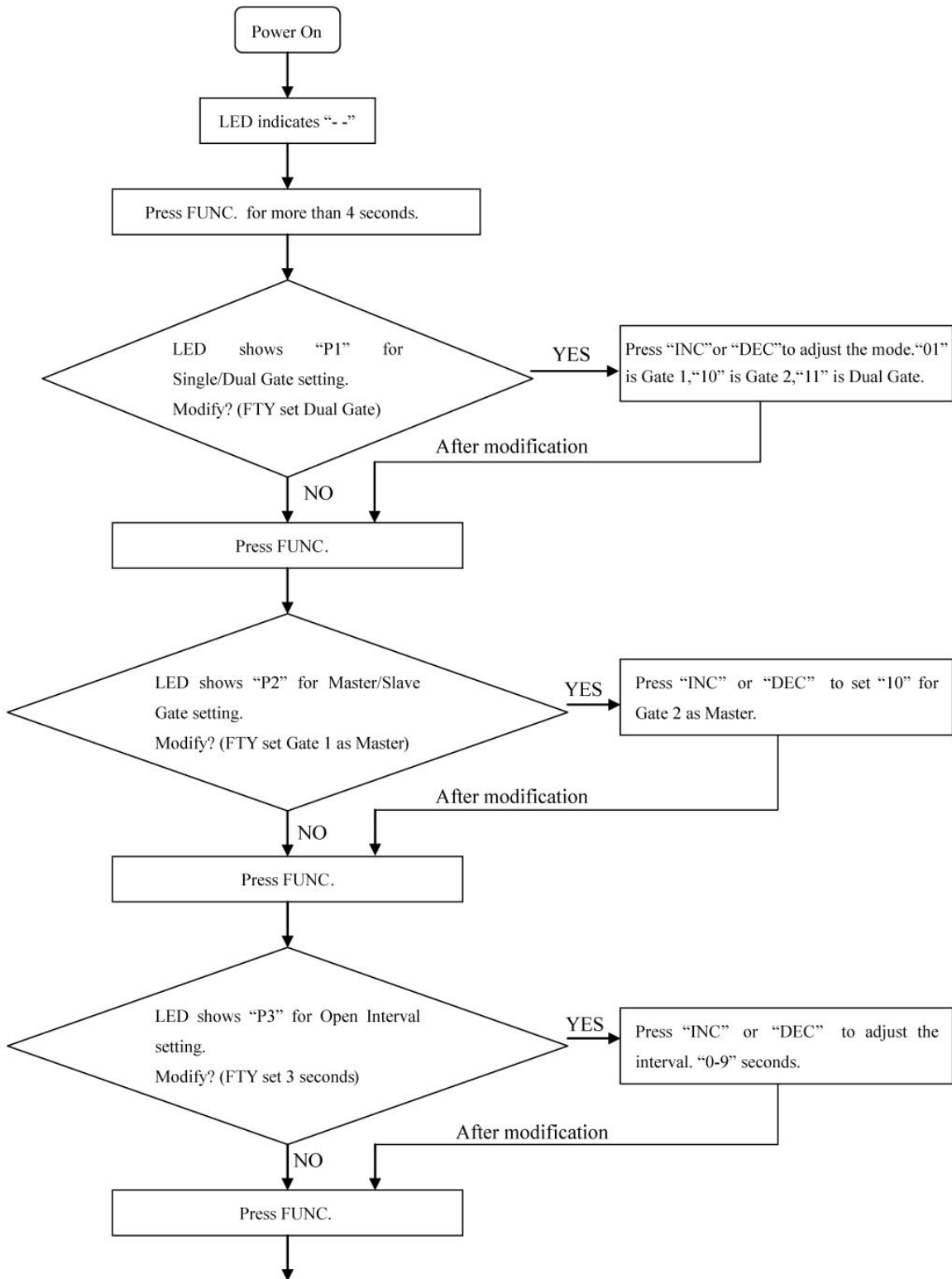

To be continued ...

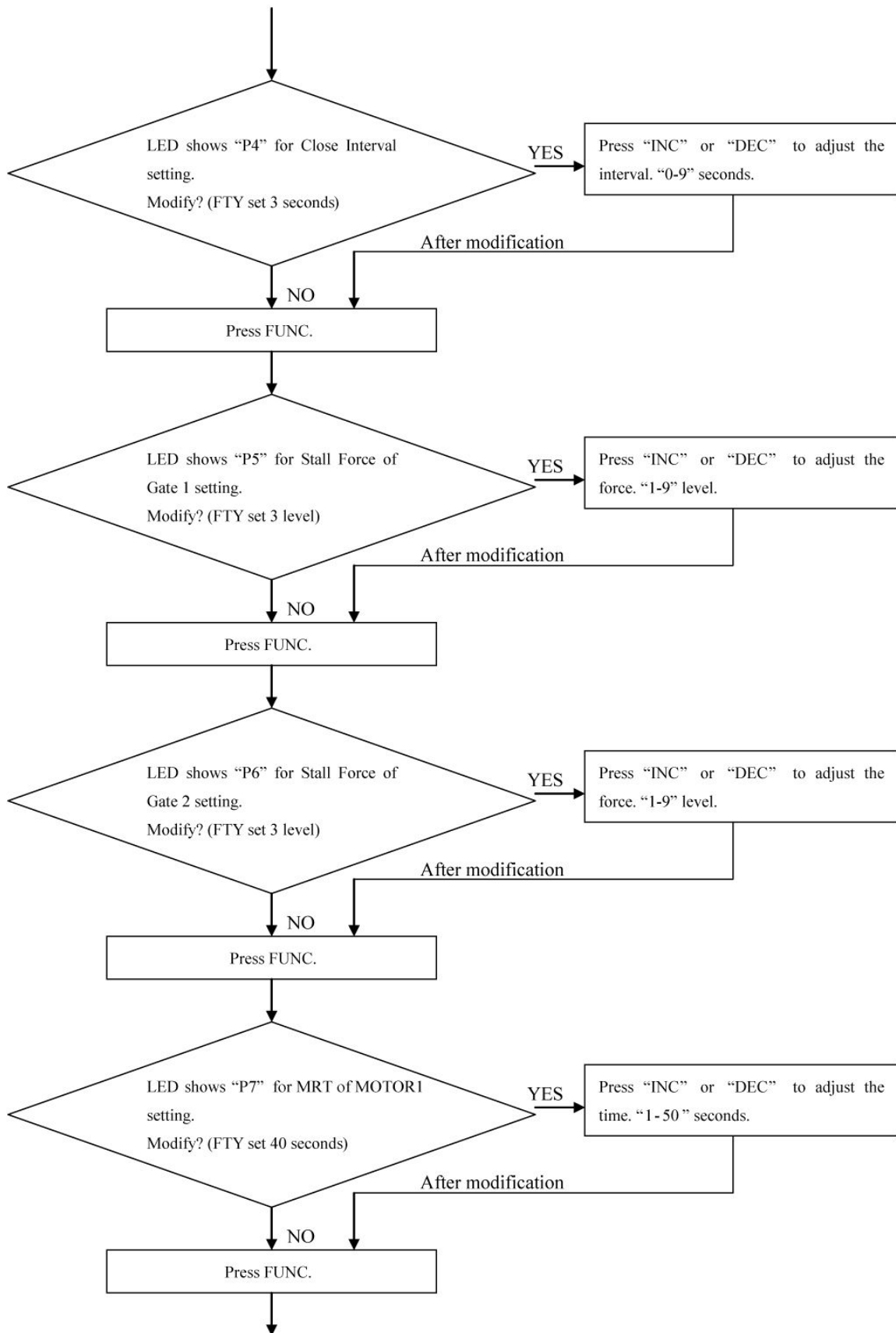

To be continued ...

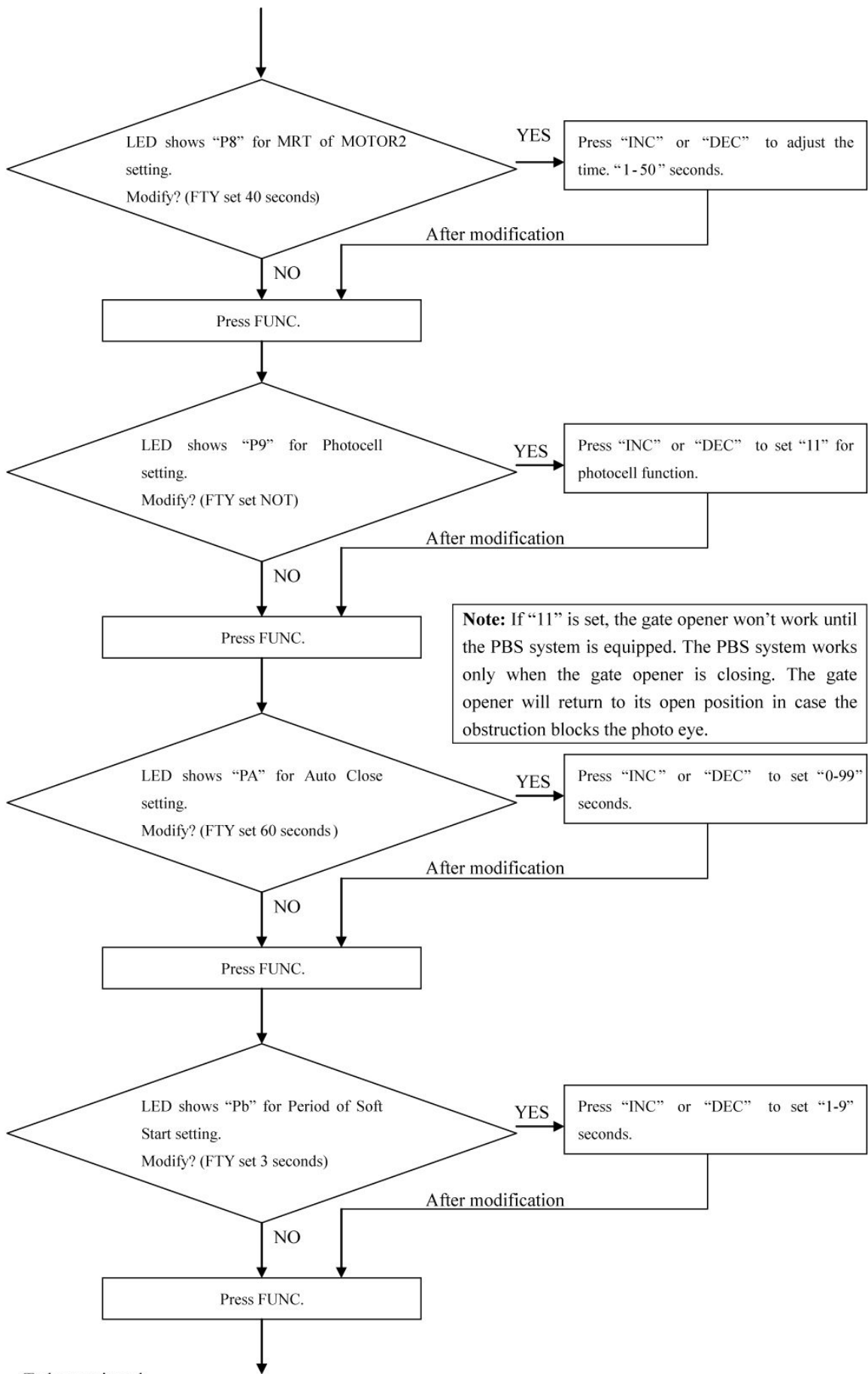

To be continued...

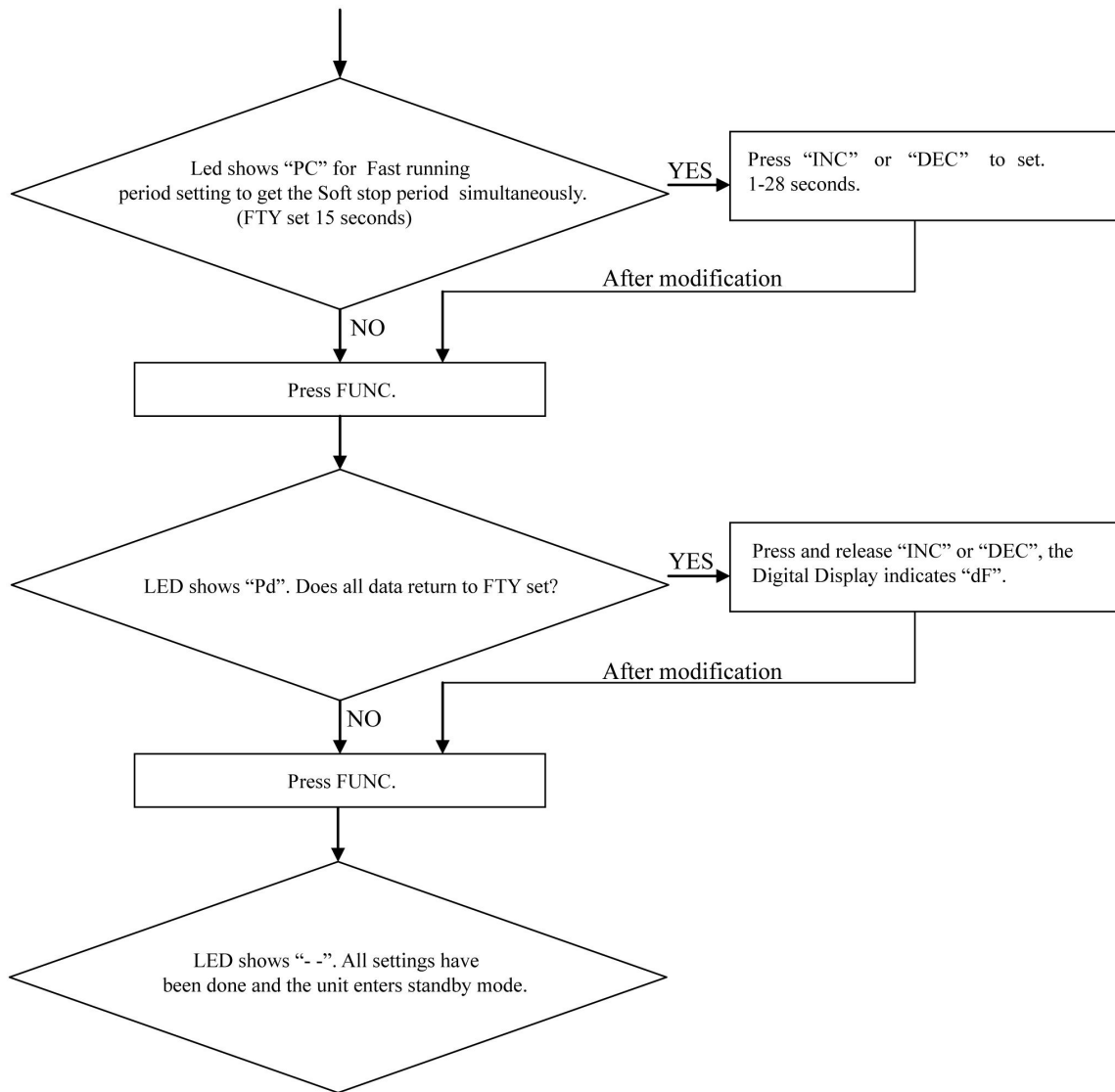

**IMPORTANT NOTICE TO USERS:**

To maintain the proper working condition of your new automatic gate opener, we recommend that you spray the actuator shaft every 4~6 weeks with silicone. This will keep the actuator working freely and prevent problems.

## **NOTICE**

We strongly recommend using AC power for this gate opener system in a daily operation. The SOL KIT ( 24V /7AH battery and 20W solar panel packed in the case) is for temporary backup power source only.

Charge the battery before the first use of the solar system to make sure there is enough electricity to power the gate opener.

If you are going to use battery and solar panel as a daily power source, please purchase extra powerful 20AH battery and 50W solar panel in addition to your 20W solar panel from local dealer.

If there isn't plenty of sunshine but bountiful wind in your area, you may also purchase (WGS) wind generator system as an auxiliary wind-solar hybrid power source from local dealer. At least 60-100 AH capacity battery should be put into use for 200W-300W wind-turbine generator system.

